

ONWA[®]

MODEL KP-1299

- High resolution TFT day-view LCD display
- SD-cards slot for C-Map MAX and user data
- C-Map MAX and K-Chart Selectable
- Tide table
- Versatile display mode include
 - Plotter Screen
 - Nav.Data
 - Satellite Information
 - AIS Display
 - Compass Screen
 - Wind Screen
- GOTO track navigation
- Map orientation select
- Proximity waypoints alarms
- Perspective View
- Palette
 - Normal
 - Daylight - exposed to sunlight
 - Night - in dark environment
 - NOAA- paper chart colors
 - Celestial

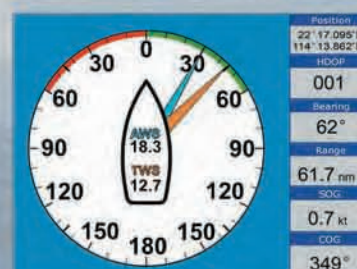
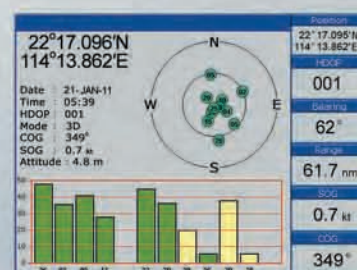
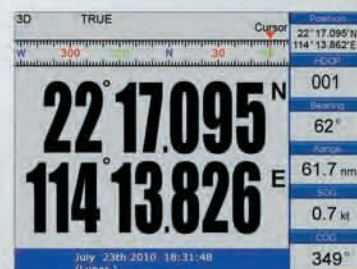
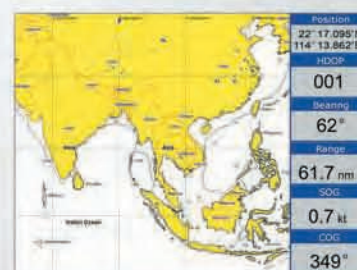
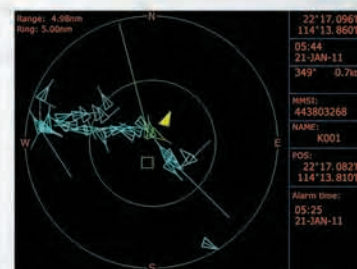

KP-1299

SPECIFICATION OF KP-1299

PLOTTER CHARACTERISTICS

Waypoints/icons:	14,000 waypoints with name, symbol, 10 proximity waypoint
Routes:	waypoint up to 169 points each, plus MOB and Track Navigation or Goto Track modes
Tracks:	21,000 point automatic track log; 10 saved track (up to 2100 track points each)let you retrace your path in both directions
Alarms:	XTE, Anchor drag, arrival, speed, voltage, proximity waypoint and time,AIS alarm.
Palette:	Normal Daylight exposed to sunlight Night in dark environment NOAA paperchart colors
Tides:	Tide data
Projection:	Mercator projection
Position format:	Lat/Lon
Basemap:	Built-in Onwa K-Chart
External Map:	SD Cards slot for C-Map MAX
User data storage:	Internal backup of user settings, or external SD-card
Plot Interval:	1s to 99h or 0.01 nm to 9.99nm
Plotting scales:	0.01nm to 1,000nm
Nav Data:	Inputs: \$--DBT, \$--DPT, \$--GGA, \$--GLL,\$--GSA, \$--GSV, \$--HDG,\$--HDM,\$--HDT,\$--MTW, \$--RMB,\$--RMC, \$--VTG, \$--ZDA, \$--VWR,\$--VWT,\$--MWD, \$--VPW Outputs: \$--AAM, \$--APB, \$--BOD,\$--BWC,\$--GGA, \$--GLL, \$--RMB,\$--RMC,\$--VTG, \$--XTE, \$--ZDA, \$--WPL, \$--ZDL, \$--ZTG Outputs for autopilot: \$--AAM, \$--APB, \$--BOD,\$--VTG
Perspective View:	On/off
Celestial:	Sunrise/Sunset Moonrise/Moonset

Power Supply 10.5 to 35VDC, current drain <1200mA at 12V

Physical

Size:	363.8mm(H)X267.9mm(W)X106mm(D)
Weight:	3.95kg
Display:	12.1-inches ColorTFT day-view LCD 800 X 600 pixels
Waterproofing:	Display unit: IPX5 Antenna unit: IPX6
Temperature range:	Display unit: -15°C to +55°C Antenna unit: -25°C to +70°C

GPS RECEIVER CHARACTERISTICS

Receiver:	50 parallel channel GPS receiver continuously Tracks and uses up to 50 satellites to compute and update your position
Acquisition times:	Cold start: 27 seconds average Warm start: 27 seconds average Hot start: 1 seconds average
Update rate:	1/second,continuous
Accuracy:	Position: 2.5 meters(95%) without S/A Velocity: 0.1 Meter/sec without S/A Time: ±100ns synchronized to GPS time
Dynamics:	Altitude: 50,000m Max Velocity: 500 m/s Acceleration: 4g Max
Datum:	WGS 84 & Others
Interfaces:	NMEA 0183 input, RS232 output
Antenna:	KA07

AIS interface

Data input:	NMEA0183, RS232
Baud rate:	38,400

EQUIPMENT LIST

- Standard
1. Display unit
 2. Antenna unit with 10m cable
 3. Operator manual
 4. Installation materials and standard spare parts

DISPLAY UNIT

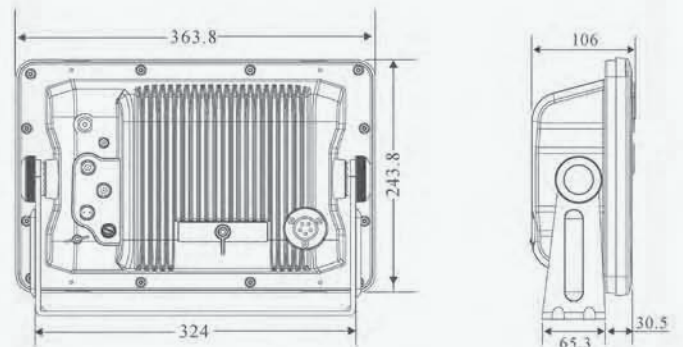
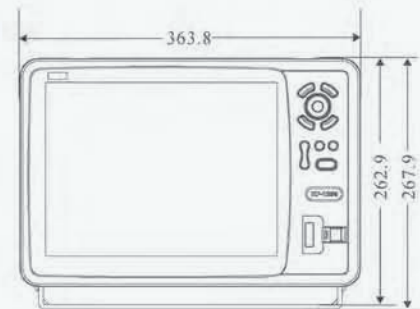

INTERCONNECTION DIAGRAM

