

NTW-1000

TWO-WAY VHF RADIOTELEPHONE

USER'S MANUAL

NEW SUNRISE

NOTICE TO USERS

- Thanks for your purchasing this product **NTW-1000 TWO-WAY VHF RADIOTELEPHONE**.
- Please read this manual carefully to ensure proper use before installation and use of the **NTW-1000**.
- **NSR will assume no responsibility for the damage caused by improper use or modification of the product or claims of loss of profit by a third party.**
- **Software version in your product may be some different from that described as in this manual. Such difference will not affect the performance of the product. NSR reserves the right of continuous improvement on products both in software and in hardware without any prior notice.**
- **The copyright of this manual is owned by the manufacturer, NEW SUNRISE CO., LTD (NSR). Prior written permission is required for copying or reproducing the manual or part of the manual.**
- **Please keep the manual for your future reference.**

WARNING

The emergency lithium battery supplied with NTW-1000 is only for use in emergency situation. As one-time battery, the emergency battery should be replaced by new one, if it has been used no matter how long.

If the protection label on the battery is taken off, the battery is regarded as being used.

The battery should be replaced when the marked expiry date is reached, even it has never been used.

Dispose the lithium batteries carefully. Lithium batteries should have two poles insulated prior to disposal because the remaining power could cause severe harm to human beings. Local regulations should be followed when batteries are disposed in order to protect your environments.

TABLE OF CONTENTS

1. OVERVIEW	1
2. PRODUCT DESCRIPTION	1
2.1 PRODUCT COMPOSITION	1
2.2 Description of Components	2
2.3 Display on LCD Panel	3
3. Specifications	4
4. GENERAL OPERATION	5
4.1 Power ON/OFF	5
4.2 Channel Selection	5
4.3 Squelch Level Adjustment	5
4.4 Transmitting	6
4.5 Receiving	6
4.6 Receiving Function Check	6
4.7 Volume Level Adjustment	6
5. SETUP FOR OPTIONAL FUNCTIONS	7
5.1 TX Power Level	7
5.2 KEY Locking	8
5.3 Battery Save Mode	9
5.4 Dual Watch	10
5.5 Beep Establishment	11
5.6 Squelch Level	12
5.7 Location Indication	13
6. BATTERY & CHARGER	14
6.1 Install the battery	14
6.2 Remove the battery	15
6.3 Emergency Battery	15
6.4 Chargeable Battery	16
6.5 Charger	16
7. MAINTENANCE	17

1. OVERVIEW

NTW-1000 is a two-way VHF radiotelephone for use on-board and on-scene communication, as part of GMDSS.

NTW-1000 includes 19 VHF simplex channels assigned to marine use by ITU. Frequency range of those channels is 156.300MHz ~ 156.875MHz.

NTW-1000 can also be used as normal VHF radiotelephone simply by upgrading the s/w into full ITU channels.

NTW-1000 is designed to comply with IMO A.694(17), IMO MSC.149(77).

Main features are:

- Small, lightweight and easy-to-use. Capable of being brought and operated easily by unskilled personal, even wearing gloves.
- Watertight to a depth of 1 m for at least 5 min and not unduly affected by seawater or oil.
- A primary battery have sufficient capacity to ensure 8 hours operation at its highest rated power with a duty cycle of 1:9 and a shelf life of at least 4 years.
- Either primary battery or secondary battery is available.
- Clearly visible orange color. Easily identified, even at a dark place.
- External MIC/Speaker can be attached.

2. PRODUCT DESCRIPTION

2.1 PRODUCT COMPOSITION

Standard equipment list for NTW-1000:

- Transceiver
- Antenna
- Primary Battery (emergency battery): Part No.NBT200.
- Secondary Battery (chargeable battery): Part No.NBT200C.
- Battery Charger: Part No.NBT200CU.
- Recharge Adapter
- Belt Clip
- Waist Rope
- User Manual

2.2 Description of Components

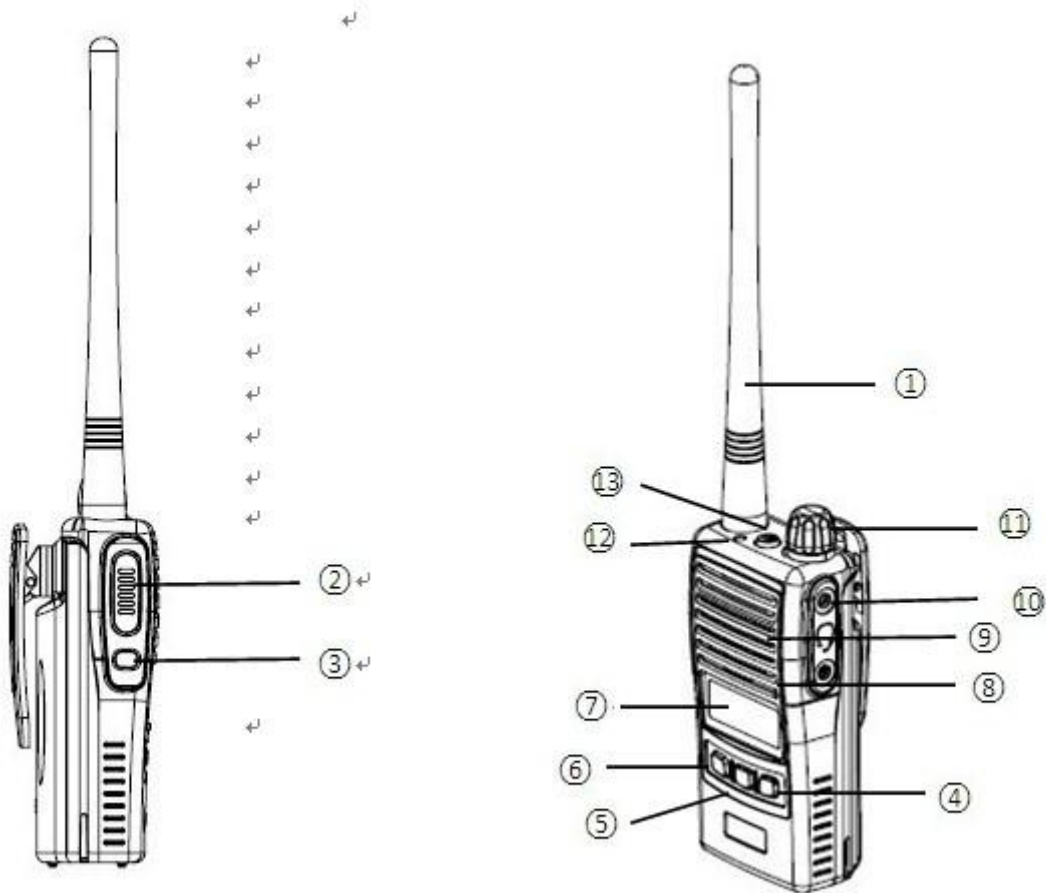

(1) Antenna

(2) PTT Key

Press to transmit.

(3) SQ LEVEL selection / Receiving Check Key

Used to switch of SQ LEVEL

Press and hold this key over 2 seconds to monitor an appropriate channel (🔊) with beep sound.

To stop the function, press the key once again.

(4) Up Key

Change the channel or select an alternative.

(5) Enter Key

Confirm the selection or change the sub-menu.

(6) Down Key

Change the channel or select an alternative.

(7) LCD

Indicates channel number, current status of battery, selected function, etc.

(8) Microphone

When transmitting, the microphone shall be positioned at the distance of 5~7cm from your mouth.

(9) Speaker

(10) External Earphone/MIC and Programming Jack Socket

External EAR/MIC can be connected via this jack.

If this has been connected, internal microphone and speaker are muted..

(11) Power on / off and Volume Control Switch

Used as ON/OFF switch. When power had been turned ON, it can be used for adjusting a sound level.

(12) LED

Indicate transmitting/receiving status by color in red and green correspondingly.

(13) CHANNEL.16

Press the key to change to Ch.16 immediately.

(14) Battery Lock

Press the battery lock to remove the battery.

2.3 Display on LCD Panel

(1) H / L : Transmitting Output Power - H(3 W), L(0.5W)

(2)  : Button Lock

(3)  : Battery Level Indicator

(4) D.W : Dual Watch Mode

The dual watch mode allows Ch.16 to be received when the other channel is activated. Refer to paragraph 4.1.

(5)  : BEEP

(6)  : Receiving Status Indicator



3. Specifications

- **Frequency range** 156.300 ~ 156.875MHz
- **Output Power** HIGH 3.0W / LOW 0.5W
- **Communication Methods** Simplex
- **Usable Channels** 19 Channels
- **Channel Space** 25kHz
- **Warming Up Time** Within 5 Sec
- **Battery Voltage** 7.2V(DC)
- **Battery Storage** 4 years
- **Operating Time** Over 8 Hour (TX 10%, RX 10%, standby 80%)
- **Operating Temperature** -20 °C~ + 55 °C
- **Watertight** At least 5 min at 1m depth
- **Dimension** 51(W)×33(D)×256(H)mm
- **Weight** Transceiver: 163g
Transceiver with emergency battery: 250g
Transceiver with chargeable battery: 280g

4. GENERAL OPERATION

4.1 Power ON/OFF

- **Power ON**

Turn the ON/OFF & Volume knob clockwise to switch ON the equipment and a latest established status including channel number and usable battery capacity will be displayed.

It will take 1 second from power ON to standby condition.

- **Save the latest established data**

Turn the ON/OFF & Volume knob counterclockwise to switch the power OFF.



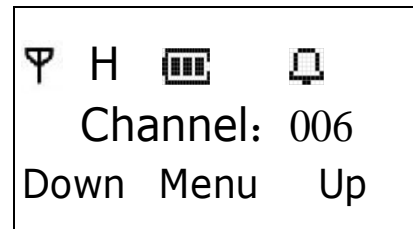

Now, if you switch ON it again, the latest used channel number, squelch level, output power level and other established menu items will be loaded automatically.



Attention: The status of Dual Watch Function is also saved.

4.2 Channel Selection



To establish the desired channel, use  or  (UP/DOWN) key .

Press  or  (Up/Down) key to change the channel number. Press  key via the highest channel number will make a move to the lowest channel number and pressing  key via the lowest channel number will make a move to the highest channel number.



Press  key on the topside of the equipment to establish Ch.16 immediately.

4.3 Squelch Level Adjustment

Press  key located on the low left side of the equipment. The squelch level is ready to be adjusted.

Select a desired squelch level by using  or  key and press  (Enter) key to ensure selected squelch level. Then display will return to initial screen.

Attention:

1. If  or  key is not pressed consequently, the value on the display will be established as a squelch level automatically and then the status of the initial screen will return.
2. Value of squelch level has been established 8 by default.

4.4 Transmitting

To transmit on the current channel in receiving or standby mode, press  (PTT) key on the left side of the equipment and talk by positioning the microphone near to your mouth.

Release  (PTT) key to stop speaking and return to receiving or standby mode.

By pressing  (PTT) key for transmission, Tx/Rx indicator will be lit up with red color.



4.5 Receiving

If any signal has been received in standby mode, TX/RX indicator will be lit up with green color and  mark appears on the display.

Attention: *Receiving is impossible with PTT key pressed.*

4.6 Receiving Function Check

This function allows ensuring that the receiving function is in operation.

Press  key more than 2 seconds to check the receiving function and press  key once again to stop the check.

4.7 Volume Level Adjustment

To adjust the volume of receiving sound, turn the ON/OFF & Volume knob in a desired direction.

Turn it clockwise to raise the receiving sound and turn it counterclockwise to reduce it.

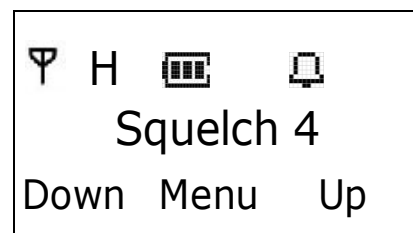

5. SETUP FOR OPTIONAL FUNCTIONS

5.1 TX Power Level

- First of all, ensure which power level has been established in the receiving or standby mode. The High is displayed as “H”



- The Low is displayed as “L” .

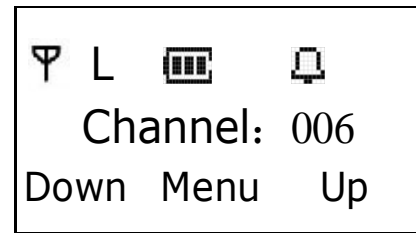

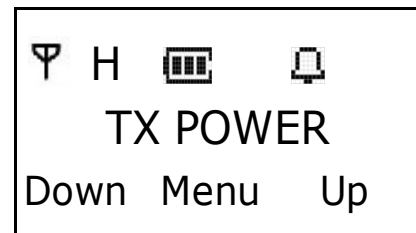

- To change current power level, press  (Enter) key to enter into the optional menu mode. The display appears to be as “TX POWER” .



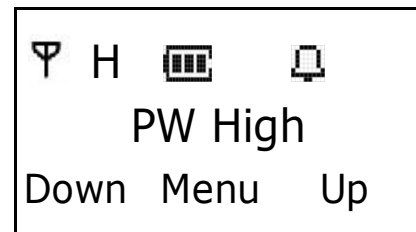

- Press  (Enter) key in the above status to enable transmitting power level to be changed. If the High(3W) has been established,

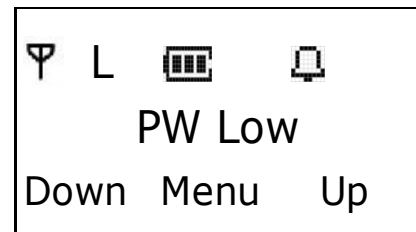

- If the Low (0.5W) has been established to choose an alternate power level, press  or  key and then press  (Enter) key to enable a desired power level to be displayed.



Attention:



1. If  or  key is not pressed within 3 seconds in the above status, the display will return to default screen.
2. Transmitting power on Channel 15 an Channel 17 is fixed to L(0.5W)

5.2 KEY Locking

This function is used to prevent an inadvertent establishment resulting from carelessness or mistake of operator.

If this function is established, all keys excluding the PTT switch, Receiving Check key and the **16** key on the topside of the equipment, can't be activated.

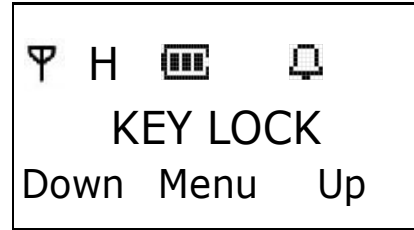

- Press  (Enter) key to enter into optional menu mode.

Press  or  key several times until "KEY LOCK" is displayed.

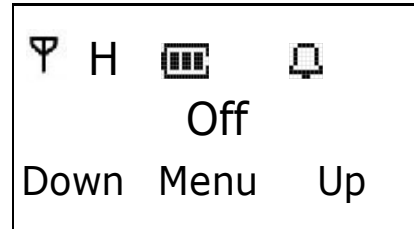

- Press  (Enter) key to activate or release the key locking.



- If it is displayed as "Off", press  or  key within 3sec consequently to choose the ON status. Press  (Enter) key within 3sec consequently to ensure the ON status is displayed.

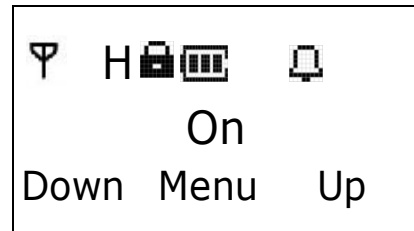

- If the key locking function has been released and the lock mark  will disappear.

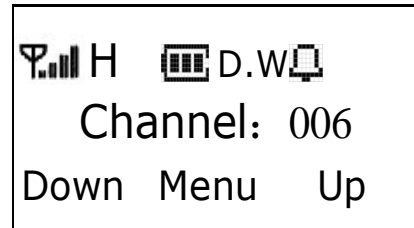

- To release the key locking, the  (Enter) key should be pressed more than 2 seconds.

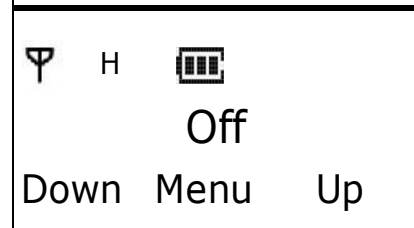
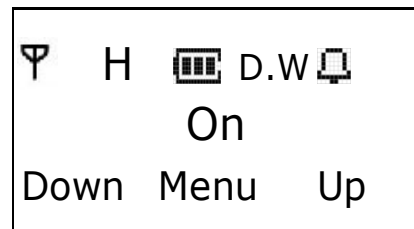



Attention:

1. If no key is pressed consequently in above status, it escapes from the optional menu mode and return to initial screen.
2. Even if key locking has been established, PTT switch, Receiving Check key and CH.16 key are activated.

5.3 Battery Save Mode

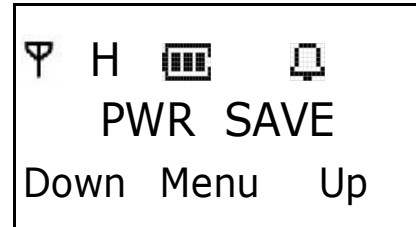

This function enables to extend the usable time of the battery. The establishment of the function permits to carry out minimized activities in operating equipment so that it can manage the required power for each built-in device effectively.

- To establish the economy battery mode, press  (Enter) key to enter into the optional menu mode. Press  or  key within 3 seconds consequently in the above status until "PWR SAVE" is displayed.

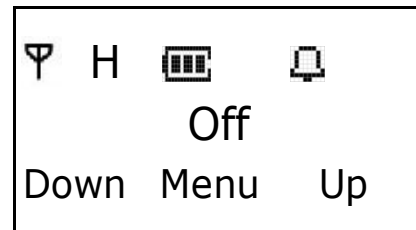

- Press  (Enter) key again within 3 seconds consequently in the above status to ensure the current status as "On" or "Off". If it hasn't been established for the economy battery mode, "Off" is displayed..



- To establish the economy battery mode, press  or  key to choose and then press  (Enter) key to confirm.

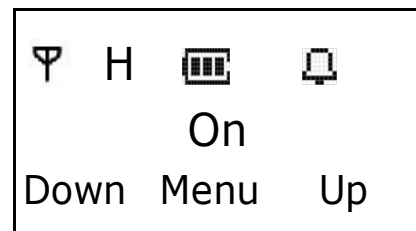

Attention:

1. Battery save mode has been set to OFF by default.

5.4 Dual Watch

This function allows the receiving on Ch.16 together with current channel simultaneously.

- The DW mark on the screen means that dual watch function has been established.

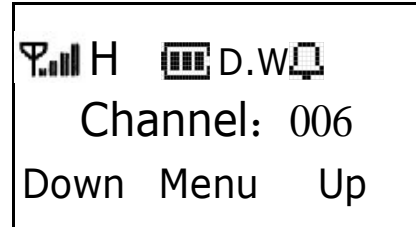

- Press  (Enter) key to enter into optional menu mode. "D-WATCH" is displayed.





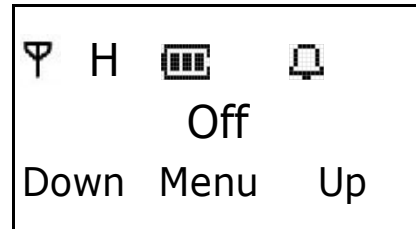
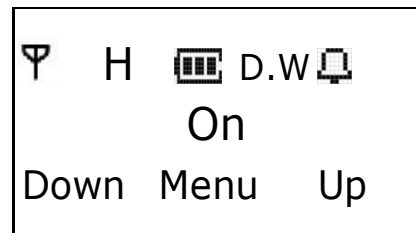

- Press  (Enter) key within 3 seconds consequently in the status and then either "On" or "Off" is displayed.



Attention:



1. Dual watch mode has been set to OFF by default.

5.5 Beep Establishment

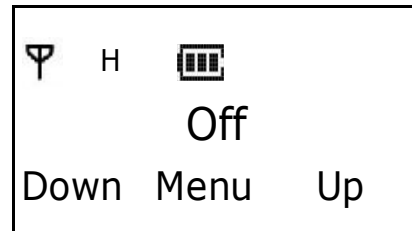
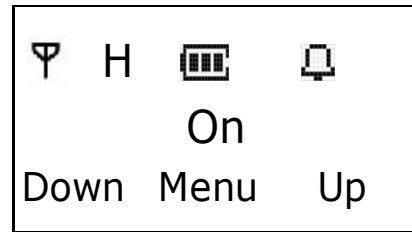
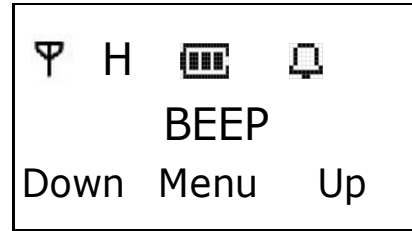
- This function is established to generate or mute audible tone such as "Pi-" sound when any key except the PTT switch is pressed. The bell mark "🔔" on the LCD indicates that the beep has been established.
- Press  (Enter) key to enter into optional menu mode. Otherwise, press  or  key several times until "BEEP" is displayed.
- Press  (Enter) key within 3sec consequently. If the beep has been established already, "🔔" is indicated.
- If the beep hasn't been established, the bell mark "🔔" is not indicated in the initial screen and "OFF" is displayed.





Attention:



1. Press  or  key to choose ON or OFF status and press  (Enter) key within 3 seconds consequently to ensure a desired status is displaying.
2. Beep mode has been set to ON by default.

5.6 Squelch Level

This function has already been mentioned in Paragraph 4.3-"Squelch Level Adjustment".
The squelch level can also be established in the optional menu mode.

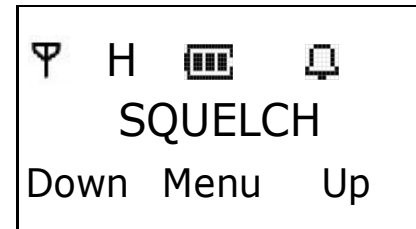

- Press  (Enter) key to enter into optional menu mode.
Otherwise, press  or  key several times until "SQUELCH" is displayed.

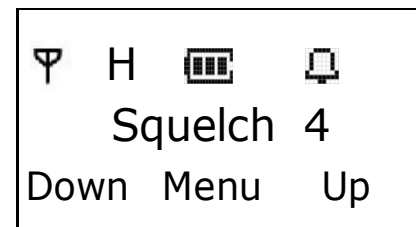

- Select a desired squelch level by using  or  key and then press  (Enter) key within 3 seconds consequently to confirm the selected squelch level. Then display will return to initial screen.





Attention:

1. Press  or  key to choose ON or OFF status and press  (Enter) key within 3sec consequently to ensure a desired status is displaying.
2. Value of Squelch Level has been set to 4 by default.

5.7 Location Indication



This function is to find the equipment easily. If this function has been established, the LED for Tx/Rx indicator will blink every 15 seconds in green color to be easily located in the darkness.

- To establish the location indication mode, press  (Enter) key to enter into the optional menu mode.
Press  or  key within 3 seconds consequently in the above status until "LOCATION" is displayed.



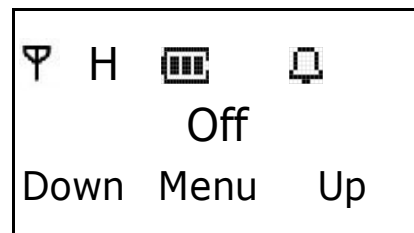

- Press  (Enter) key again within 3 seconds consequently in the above status to ensure the current status as "ON" or "OFF".
If it hasn't been established for the location indication mode, "OFF" is displayed.

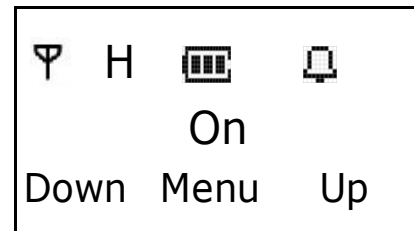

- To establish the location indication mode, press  or  key to until ON is displayed and then press  (Enter) key to confirm it.



Attention:

- Press  or  key to choose ON or OFF status and press  (Enter) key within 3 seconds consequently to confirm the desired status.
- Location indication mode has been set to OFF by default.

6. BATTERY & CHARGER

6.1 Install the battery



- Press the battery against the transceiver..
- Push the battery upside in position.

6.2 Remove the battery



- Press the black battery lock hardily with one hand.
- Pull the battery with the other hand..

Attention:

1. The battery cannot be easily removed if the black battery lock is not pressed enough to release.

6.3 Emergency Battery

The emergency lithium battery supplied with NTW-1000 is only for use in emergency situation. As one-time battery, the emergency battery should be replaced by new one, if it has been used no matter how long.

If the protection seal on the battery is taken off, the battery is regarded as being used.

The battery should be replaced when the marked expiry date is reached, even it has never been used.

Attention:

Dispose the lithium batteries carefully. Lithium batteries should have two poles insulated prior to disposal because the remaining power could cause severe harm to human beings. Local regulations should be followed when batteries are disposed in order to protect your environments.

6.4 Chargeable Battery

The chargeable battery used for NTW-1000 is fast charging battery with stability and high-reliability. The battery should be fully charged before using for best capacity and safe operation. Don't charge the battery by the charger not supplied by NSR because the battery is designed to use only dedicative charger of manufacturer. If the battery is assembled with transceiver, it should be charged when the transceiver is powered off. Don't make the battery to be short-circuit. Capacity for the chargeable battery is 2200mAh.

6.5 Charger

6.5.1 Specifications:

- Input voltage: **DC 12V/1A**
- Charging time: **Around 160 minutes**
- Operating temperature: **0°C ~ +40°C**
- Charging current: **850mA (±10%)**

6.5.2 Charging the battery

The charger can be used to charge the batteries in three ways:

- Only one battery
- Only one battery assembled with the transceiver
- One battery and the other battery assembled with the transceiver together

The charging status can be identified from the LED indicator as below:

* Charger LED indicator

Red LED	Charging
Green LED	Fully charged
Yellow LED	Charging pending or battery overheating
Red LED is blinked	Battery malfunction or pre-charging mode

Two LEDs, FRONT and REAR, will indicate the charging status for two batteries respectively.

6.5.3 Fast charging

In case of that batteries are fully discharged, the charger goes into Pre-Charge Mode, in which LED indicator blinks in red.

Leave the fully-discharged battery to be charged for ten minutes until the normal voltage is arrived. Then release the battery from the charger and put it back. The charger enters into Fast-Charge Mode, and the LED indicator stays red instead of blinking.

6.5.4 Install the charger

The charger can be mounted on table.

Remove the two rubber caps from the two mount holes at bottom of two battery slots and fix the charger on table with two screws.



7. MAINTENANCE

The below troubleshooting table provides common symptoms of troubles and means to rectify them. Even it is impossible to restore with normal operation, don't attempt to check inside the equipment. Any repairing should be done by a qualified technician.

SYMPTOM	INSPECTION
Can't turn on the power	<ul style="list-style-type: none"> ● Confirm that the battery has been assembled in its place properly. ● Separate the battery from the equipment to ensure that the contact plane not to be wetted or covered with the dust. If the contact plane between battery and transceiver is wetted or covered with the dust, clean and dry it with a piece of cloth. ● Ensure whether battery has been discharged completely. Secondary battery could be charged through the battery charger. Primary Battery should be purchased from authorized agency due to charging is impossible. ● Ensure that the knob of On/Off & Volume knob has been turned correctly. ● Contact manufacturer or its authorized dealer for service.

NTW-1000, TWO WAY RADIO LAY-OUT

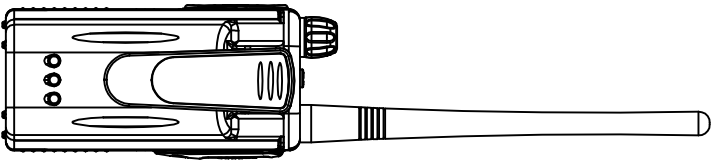
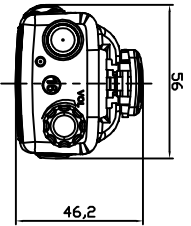

BACK VIEW

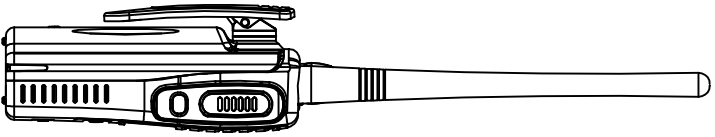

LEFT SIDE VIEW

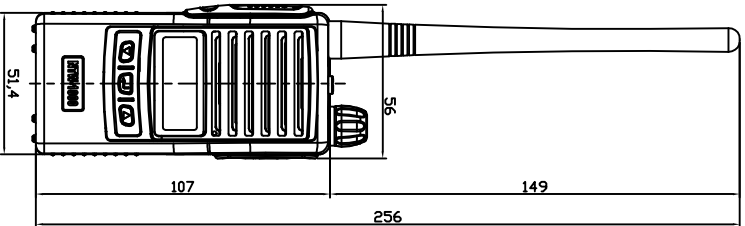

FRONT VIEW

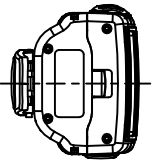

BOTTOM VIEW

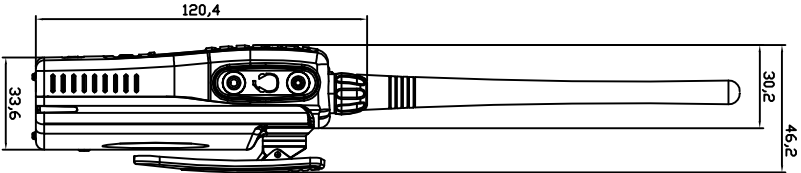

RITE SIDE VIEW

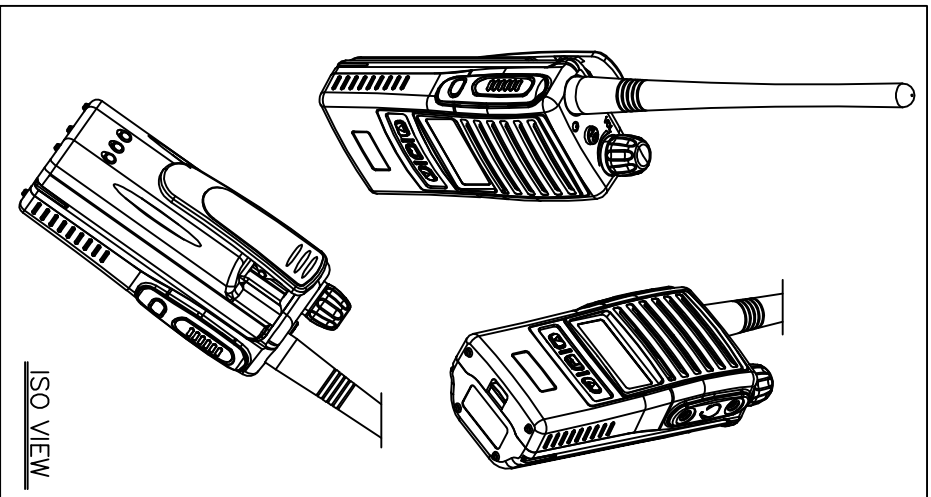

ISO VIEW

NO.	DATE	REVISION & DESCRIPTION	REVIEWED & CHECKED SIGNATURE

NO.	DESCRIPTION	MATERIAL QUANTITY	WEIGHT	REMARK'S	DWG NO.
APPLICATION NTW-1000, TWO WAY RADIO LAY-OUT					
DATE	2011.05.09	ITEM	NTW-1000 TWO WAY RADIO		SIZE A4
APPROVAL		SCALE 1/3	UNIT mm	PROJ. 08	
CHECKED		DRAWING			
DWG NO.	NTW1000-DW-000	 NEW SUNRISE CO., LTD.			